



HAL
open science

A new interpolation technique to deal with fluid-porous media interfaces for topology optimization of heat transfer

Delphine Ramalingom, Pierre-Henri Cocquet, Alain Bastide

► **To cite this version:**

Delphine Ramalingom, Pierre-Henri Cocquet, Alain Bastide. A new interpolation technique to deal with fluid-porous media interfaces for topology optimization of heat transfer. *Computers and Fluids*, 2018, <10.1016/j.compfluid.2018.04.005>. <hal-01618684>

HAL Id: hal-01618684

<https://univ-reunion.hal.science/hal-01618684v1>

Submitted on 18 Oct 2017

HAL is a multi-disciplinary open access archive for the deposit and dissemination of scientific research documents, whether they are published or not. The documents may come from teaching and research institutions in France or abroad, or from public or private research centers.

L'archive ouverte pluridisciplinaire **HAL**, est destinée au dépôt et à la diffusion de documents scientifiques de niveau recherche, publiés ou non, émanant des établissements d'enseignement et de recherche français ou étrangers, des laboratoires publics ou privés.



HAL Authorization

A new interpolation technique to deal with fluid-porous media interfaces for topology optimization of heat transfer

Delphine Ramalingom^{a,*}, Pierre-Henri Cocquet^a, Alain Bastide^a

*^aUniversité de La Réunion, Laboratoire PIMENT
117 Avenue du Général Ailleret
97430 Le Tampon, France*

Abstract

This paper proposes a new interpolation technique based on density approach to solve topology optimization problems for heat transfer. Problems are modeled under the assumptions of steady-state laminar flow using the incompressible Navier-Stokes equations coupled to the convection-diffusion equation through the Boussinesq approximation. The governing equations are discretized using finite volume elements and topology optimization is performed using adjoint sensitivity analysis. Material distribution and effective conductivity are interpolated by two sigmoid functions respectively $h_\tau(\alpha)$ and $k_\tau(\alpha)$ in order to provide a continuous transition between the solid and the fluid domains. Comparison with standard interpolation function of the literature (RAMP function) shows a smaller transition zone between the fluid and the solid thereby, avoiding some regularization techniques. In order to validate the new method, numerical applications are investigated on some cases from the literature, namely the single pipe and the bend pipe. Lastly, as

*Corresponding author: delphine.ramalingom@univ-reunion.fr

two new parameters are introduced thanks to the interpolation functions, we study their impact on results of the optimization problem. The study shows that the proposed technique is a viable approach for designing geometries and fluid-porous media interfaces are well-defined.

Keywords: Topology optimization, Heat transfer, Interpolation function, Sigmoid function, Continuous adjoint method, Finite volume method

1. Introduction

Since its introduction by Bendsoe and Sigmund [1] for solid mechanics problems, topology optimization has become a powerful and increasingly popular tool for designers and engineers for design process. Topology optimization is a material distribution method for finding the optimal structure, for a given problem subject to design constraints. Contrarily to shape optimization where the topology (i.e. the number of boundaries and connectivity) is predetermined, topology optimization allows introduction of new boundaries during the design process.

Topology optimization was pioneered for Stokes flow by Borrvall and Petersson [4]. They introduced a friction term yielding the generalized Stokes equations. Gersborg-Hansen [9] and Olesen et al. [8] extended topology optimization for fluid flow problems to the Navier-Stokes equations.

In topology optimization, the material distribution is parametrized by defining a design variable $\alpha \in \{0; 1\}$. This variable is discrete and should either represent solid material ($\alpha = 1$) or fluid ($\alpha = 0$). A common approach to solve the topology optimization problem with this discrete value as optimization parameter, is to change it into a continuous one by introducing a

19 porous media with a continuous permeability variable for each element. This
20 method, known as the Brinkman penalization, leads to a problem where flow
21 and (almost) non-flow regions are developed by allowing interpolation be-
22 tween the lower and upper value of permeability. Generally, authors used
23 the density interpolation function proposed by Borrvall and Petersson [4]
24 or a reformulated version of their convex and q -parametrized interpolation
25 function. The parameter $q > 0$ is a penalty parameter that is used to con-
26 trol the level of 'gray' in the optimal design. However, authors had also
27 experienced problems with locally optimal solutions. Therefore, they con-
28 sidered a two-steps solution procedure where the problem was first solved
29 with a small penalty value of $q = 0.01$ for example and then the result is
30 used as initial case for the problem with a penalty value of $q = 0.1$ [4, 8]
31 or $q = 1$ [15]. The mathematical foundation of the interpolation of α was
32 further investigated by Evgrafov [14] where the limiting cases of pure fluid
33 and solid were included. Brinkman approach has since been used for several
34 problems as transport problem [28], reactive [32] and transient flows [33, 3],
35 fluid-structure interaction [36] and also flows driven by body forces [37].

36 A variation of the approach is presented by Guest and Prevost [2]. They
37 proposed to regularize the solid-fluid structure by treating the material phase
38 as a porous medium where fluid flow is governed by Darcy's law. In their
39 approach, flows through voids are governed by Stokes flow and, when the
40 solid phase is impermeable, discrete no-slip condition is simulated by assign-
41 ing a low permeability to the solid phase. There exists other alternatives
42 to Brinkman penalization in the literature. The level set approach to topol-
43 ogy optimization has been applied to fluid flows problems [34, 46, 41], and

44 recently the level set approach was combined with the extended finite ele-
45 ment method (XFEM) by Kreissl and Maute [5] and by Jenkins et al. [40].
46 The main drawback of the level set approach is the constraint of remeshing
47 throughout the optimization process.

48 The second difficulty in topology optimization is to deal with the differ-
49 ence in thermal conductivity in the solid and fluid domains. Most publica-
50 tions interpolate the conductivity using the SIMP method (Solid Isotropic
51 Material with penalization). This method allows to deal with the discrete
52 nature of conductivity material distribution. So, authors [6, 15, 30, 36] con-
53 sidered a continuous local thermal conductivity controlled by the design pa-
54 rameter α ranging from 0 to 1. Thanks to this function, the optimization al-
55 gorithm is able to reallocate thermal conductivity material, or creating holes
56 in its structure to reach the objective function. Moreover, the convex and
57 p -parametrized function interpolation is similar to the density interpolation
58 function of Borrvall and Petersson [4] or the RAMP (Rational Approxima-
59 tion of Material Properties)-style function as introduced by Stolpe [16, 30, 7].
60 Other methods have also been investigated. Matsumori et al. [19] presented
61 results with a linear-interpolated design-dependant volumetric heat genera-
62 tion. Dede [20] used a linear interpolation for thermal conductivity. Thus,
63 the main issue is to deal with intermediate design variables and nonphysical
64 flow solutions.

65 There are three main categories of algorithms to solve topology optimiza-
66 tion problems : gradient-free, gradient-based and hessian-based algorithms.
67 In topology optimization problems with large number of design variables,
68 gradient-based algorithms are used to find accurate solutions efficiently. One

69 of the advantages of the interpolation functions described above is the possi-
70 bility of using gradient-based continuous optimization methods. These meth-
71 ods are based on derivatives in order to find extrema, and are the so-called
72 sensitivity analysis. It aims at evaluating the derivative of objective function
73 with respect of α . Gradient-based algorithm is widely used by several au-
74 thors [27, 21, 30, 35, 47]. Moreover, since most of the topology optimization
75 problems involve a huge number of design variable, specific gradient-based
76 optimization algorithms must be chosen to handle this difficulty. A famous
77 algorithm from the literature is the MMA (Method of Moving Asymptotes)
78 developed initially by Svanberg [43]. In order to reduce the computational
79 costs, adjoint approach consisting to calculate the sensitivities of the objec-
80 tive function by an adjoint state has been adopted. Other methods have
81 been explored to reduce the computation cost: the multigrid preconditioned
82 conjugate gradients (MGCC) by Amir et al. [22], multi-resolution multi-scale
83 topology optimization technique by Kim et al. [23], the technique of using
84 adaptive design variable fields by Guest et al. [26].

85 Moreover, various regularization techniques based on filtering of either
86 the design variable α or the sensitivity $\frac{\partial f}{\partial \alpha}$ [1, 10, 15, 30, 48] exist to ensure
87 well-posed topology optimization problems. The regularization works by
88 defining a certain length scale r_0 below which any features in α or $\frac{\partial f}{\partial \alpha}$ are
89 smeared out by the filter; that results in optimized structures with a minimal
90 feature size r_0 independent of the mesh refinement. As mentioned by some
91 authors [15, 29], these regularization techniques allow to avoid checkerboard
92 problems.

93 This paper proposes a new interpolation technique in order to solve a

94 heat transfer topology optimization problem. Design material and effective
 95 conductivity are interpolated respectively by a function $h_\tau(\alpha)$ and another
 96 function $k_\tau(\alpha)$ in order to provide a continuous transition between the solid
 97 and the fluid domains. These interpolation functions avoid the use of some
 98 regularization techniques because the problem can be solved in one-step with-
 99 out a new value of the convexity parameter. Moreover, these interpolation
 100 functions allow a smaller transition zone between the fluid and solid regions.
 101 To prove this claim and get more qualitative results, the size of these tran-
 102 sition zones is explicitly computed and comparison with standard RAMP
 103 interpolation is lead. In order to validate the new method, some numerical
 104 applications are investigated on the single pipe and the bend pipe cases of the
 105 literature. Lastly, as two new parameters are introduced thanks to the in-
 106 terpolation functions, we study their impact on the results of a optimization
 107 problem.

108 2. Governing equation

109 The main goal of this paper is to solve topology optimization problems
 110 for heat transfer in fluid flow. The latter can be written in the general form
 111 below:

$$\begin{aligned}
 & \text{Minimize} \quad \mathcal{J}(\mathbf{u}, p, \theta) = \int_{\Omega} \mathcal{J}_{\Omega}(\mathbf{u}, p, \theta) d\Omega + \int_{\Gamma} \mathcal{J}_{\Gamma}(\mathbf{u}, p, \theta) d\Gamma \\
 & \text{Subject to} \quad \text{Governing equation for } (\mathbf{u}, p, \theta) \quad , \quad (1) \\
 & \quad \quad \quad \text{Boundary conditions on } \Gamma
 \end{aligned}$$

113 where \mathbf{u} , p and θ are respectively the dimensionless velocity, pressure and
 114 temperature, Ω is a bounded open set of \mathbb{R}^d , $d = 2, 3$, with boundary $\Gamma =$
 115 $\partial\Omega$. The function \mathcal{J}_{Ω} and \mathcal{J}_{Γ} are some cost functional modeling a physical

116 effect one wish to minimize. We assume that Γ can be decomposed as $\Gamma =$
 117 $\Gamma_1 \cup \Gamma_2 \cup \Gamma_{in} \cup \Gamma_{out}$ where Γ_{in} is the inlet, Γ_{out} the outlet and Γ_1, Γ_2 are going
 118 to be considered as walls.

119 For the governing equation, the flows considered in this study are assumed
 120 Newtonian and incompressible, steady and laminar. The inverse permeability
 121 field is introduced in the steady-state Navier-Stokes equations as a source
 122 term $h_\tau(\alpha)\mathbf{u}$ yielding a Brinkman model with a convection term. The set of
 123 dimensionless equations governing the conservation of momentum, mass and
 124 energy for incompressible steady-state fluid flow are the following:

$$\begin{aligned}
 (\mathbf{u} \cdot \nabla) \mathbf{u} &= -\nabla p + Re^{-1} \Delta \mathbf{u} - h_\tau(\alpha) \mathbf{u} + Ri \theta \vec{e}_y^\top & \text{in } \Omega, \\
 \nabla \cdot \mathbf{u} &= 0 & \text{in } \Omega, \\
 \nabla \cdot (\mathbf{u} \theta) &= \text{div}(Re^{-1} Pr^{-1} k_\tau(\alpha) \nabla \theta) & \text{in } \Omega.
 \end{aligned}
 \tag{2}$$

126 The reduced dimensionless temperature is $\theta = (T - T_0)/\Delta T$ and the uni-
 127 form heat flux $\Phi = \partial_n \theta$ on some part of Γ_1 is equal to $\lambda_f \Delta T/l$, with λ_f
 128 the thermal conductivity of the fluid. Parameters governing the flow are the
 129 Reynolds number defined as $Re = U_0 l/\nu$, with U the reference velocity (i.e
 130 mean velocity here) and l is the hydraulic diameter, the Richardson number
 131 $Ri = Gr/Re^2$ where Gr is the Grashof number defined as $Gr = g \beta \Delta T l^3/\nu^2$.
 132 $h_\tau(\alpha)$ corresponds to the ratio between a kinematic viscosity and a perme-
 133 ability and α is the spatially varying design variable field determined by the
 134 optimization algorithm. Regions with low permeability can be considered as
 135 solid regions since (at least formally) the velocity of the fluid vanishes in such
 136 region, and those with very high permeability regions are interpreted as pure
 137 fluid. The interpolation function for the adimensional thermal conductivity
 138 is given by $k_\tau(\alpha)$.

139 We consider the following set of boundary conditions:

$$\begin{aligned}
 & \mathbf{u} = 0, & \partial_n \theta = -1 & & \text{on } \Gamma_1, \\
 & \mathbf{u} = 0, & \partial_n \theta = 0 & & \text{on } \Gamma_2, \\
 140 & \mathbf{u}_n = 1, \mathbf{u}_t = 0 & \theta = 0 & & \text{on } \Gamma_{in}, \\
 & \partial_n \mathbf{u} = 0, & \partial_n \theta = 0, & p = 0 & \text{on } \Gamma_{out},
 \end{aligned} \tag{3}$$

141 where \mathbf{u}_n and \mathbf{u}_t are the normal and tangential components of primal veloc-
 142 ities, respectively. To summarize, we require a constant horizontal velocity
 143 and a constant temperature θ_0 at the inlet, vanishing gradient for both ve-
 144 locity and temperature of fluid at the outlet. Homogeneous Dirichlet for the
 145 velocity and Neumann boundary condition are prescribed for the tempera-
 146 ture on the walls. It is worth noting that boundary conditions on the outlet
 147 have been considered in [39] and ensure that the fluid does not re-enter in
 148 the domain.

149 3. Interpolation

150 The goal of topology optimization is to end up with binary designs, i.e
 151 avoid that the design variables take other value than those representing the
 152 fluid or the solid. The most important thing is to be sure that the inter-
 153 mediate regions (the transition zones) are unattractive with respect to the
 154 optimization problem. This is usually carried out by penalizing the inter-
 155 mediate densities with respect to the material parameters, such as inverse
 156 permeability and effective conductivity. A standard approach is to use some
 157 convex interpolation (RAMP) function [4, 30, 15]. In this section, we propose
 158 to use another interpolation function hence interpolate the inverse permeabil-
 159 ity and the effective conductivity using sigmoid functions. After giving the

160 definition of our interpolation function, we show that the transition zones
 161 of the sigmoid are much smaller than those of the standard RAMP function
 162 therefore motivating the use of such method in topology optimization.

163 *3.1. Interpolation of porosity using a sigmoid function*

164 Inverse permeability is interpolated with a sigmoid function

$$165 \quad h_\tau(\alpha, \alpha_0) = \alpha_{\max} \left(\frac{1}{1 + \exp(-\tau(\alpha - \alpha_0))} - \frac{1}{1 + \exp(\tau\alpha_0)} \right) \quad (4)$$

166 where $\alpha \in [0, \alpha_{\max}]$ with α_{\max} being the maximal value h_τ can reach. Direct
 167 computations show that $h_\tau(0, \alpha_0) = 0$ and that the following point-wise
 168 convergence holds

$$169 \quad \lim_{\tau \rightarrow +\infty} h_\tau(\alpha, \alpha_0) = \begin{cases} 0 & \text{if } \alpha < \alpha_0, \\ \alpha_0/2 & \text{if } \alpha = \alpha_0, \\ \alpha_{\max} & \text{if } \alpha > \alpha_0. \end{cases} \quad (5)$$

170 This shows that h_τ is a smooth regularization of a Heaviside step function.
 171 From (5), one can see that α_0 can be tuned to control the size of the fluid
 172 part in the computational domain. Finally, note that the definition of our
 173 interpolation function has to be changed when $\alpha_0 = 0$ since we require $\alpha \geq 0$
 174 and (4) would lead to a regularization of a step function satisfying $h_\tau(0, 0) = 0$
 175 and, for any $\alpha > 0$, $h_\tau(\alpha, 0) \rightarrow \alpha_{\max}/2$ as $\tau \rightarrow +\infty$. In order to cover this
 176 case, one can use the following interpolation function

$$177 \quad h_\tau(\alpha, 0) = \tilde{h}_\tau(\alpha) = 2 \alpha_{\max} \left(\frac{1}{1 + \exp(-\tau\alpha)} - \frac{1}{2} \right),$$

178 which satisfies $\tilde{h}_\tau(0) = 0$ and, if $\alpha > 0$, $\tilde{h}_\tau(\alpha) \rightarrow \alpha_{\max}$ as $\tau \rightarrow +\infty$.

179 *3.2. Comparison with standard RAMP interpolation function*

180 The RAMP function has been introduced in [4] and is defined as follows:

$$181 \quad h_{q,R}(s) = \alpha_{\max} + (\alpha_{\min} - \alpha_{\max})(1 - s) \frac{1 + q}{1 - s + q}, \quad (6)$$

182 where $s \in [0, 1]$ is the design parameter and $\alpha_{\min}, \alpha_{\max}$ are respectively the
 183 minimal and maximal value the RAMP function can take. Again, some
 184 direct computations show that $h_{q,R}$ is a smooth and convex regularization
 185 of a Heaviside step function since $h_{q,R}(0) = \alpha_{\min}$ and, for any $s > 0$,
 186 $\lim_{q \rightarrow 0} h_{q,R}(s) = \alpha_{\max}$. In the sequel, we use $\alpha_{\min} = 0$ since this does not
 187 add any difficulties nor plus to the discussion. We now compare the perfor-
 188 mances of our sigmoid (4) with the standard RAMP function (6) by focusing
 189 on the size of their so-called transition zones. First, note that they are both
 190 defined on Ω but the transition zone only depends on the value of the design
 191 parameter $s(x)$ for $x \in \Omega$. As a result, we are going to consider that both
 192 functions have real domain and act on the interval $[0, 1]$. Also, to compare
 193 functions having the same domain and being both smooth regularization of
 194 step function as $q \rightarrow 0$, we rescale the sigmoids (4) thanks to the formula

$$195 \quad h_{q,S}(s, \alpha_0) = h_{1/q}(\alpha_{\max}s, \alpha_0), \quad h_{q,S,0}(s) = \tilde{h}_{1/q}(s\alpha_{\max}), \quad s \in [0, 1].$$

196 By definition, the transition zones are the undesirable values of the design
 197 variable $s \in [0, 1]$ for which the velocity of the speed is not enough penalized
 198 to vanish or the value of the interpolation function is not small enough for
 199 considering these zones as fluid. As one can see from Figure 1, the sigmoid
 200 function has much smaller transition zone than the RAMP function.

201 To prove this claim and get more qualitative results we are going to
 202 compute explicitly the size of these transition zones. For a given small enough

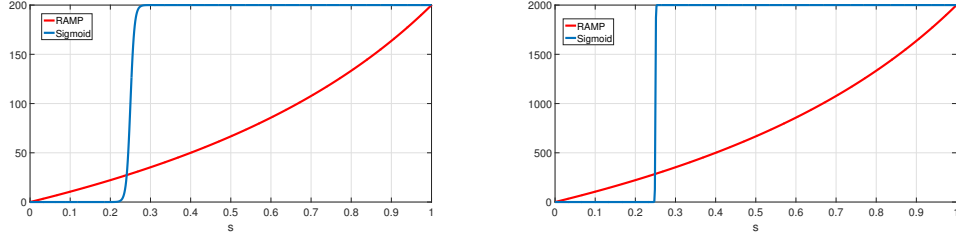

Figure 1: Interpolation functions with $q = 1$ and $\alpha_0 = \alpha_{\max}/4$. Left: $\alpha_{\max} = 200$. Right: $\alpha_{\max} = 2000$.

203 $\varepsilon > 0$ and a large enough $M > 0$, the latter are defined by

204
$$\mathcal{T}(f, \varepsilon, M) = \{s \in [0, 1] \mid \varepsilon \leq f(s) \leq M\}, f \in \{h_{q,R}, h_{q,S}, h_{q,S,0}\}.$$

205 Since both interpolation function are increasing, they admit an inverse func-
 206 tion f^{-1} and the transition zone is thus given by the interval $\mathcal{T}(f, \varepsilon, M) =$
 207 $[f^{-1}(\varepsilon), f^{-1}(M)]$ from which we infer that

208
$$|\mathcal{T}(f, \varepsilon, M)| = f^{-1}(M) - f^{-1}(\varepsilon). \quad (7)$$

209 It then only remains to compute the inverse of the sigmoid and RAMP func-
 210 tions. This is actually achieved by solving $f(s) = y$ for a given $y \in [0, \alpha_{\max}]$.
 211 These equations can be solved analytically using only direct computations

212 and give

$$213 \quad s = (h_{q,R})^{-1}(y) = 1 - q \frac{y - \alpha_{\max}}{\alpha_{\max} - y + (1+q)(\alpha_{\min} - \alpha_{\max})} = y \frac{1+q}{\alpha_{\max}q + y} \quad (8)$$

$$215 \quad s = (h_{q,S})^{-1}(y) = \frac{\alpha_0}{\alpha_{\max}} -$$

$$216 \quad \frac{q}{\alpha_{\max}} \begin{cases} -\log \left(\frac{\alpha_{\max} - y(1 + \exp(-\alpha_0/q))}{\alpha_{\max} \exp(-\alpha_0/q) + y(1 + \exp(-\alpha_0/q))} \right) & \text{if } s \leq \alpha_0/\alpha_{\max} \\ \log \left(\frac{\alpha_{\max} - y(1 + \exp(-\alpha_0/q))}{\alpha_{\max} \exp(-\alpha_0/q) + y(1 + \exp(-\alpha_0/q))} \right) & \text{if } s \geq \alpha_0/\alpha_{\max} \end{cases}$$

$$217 \quad s = (h_{q,S,0})^{-1}(y) = -\log \left(\frac{\alpha_{\max} - y}{\alpha_{\max} + y} \right) \frac{q}{\alpha_{\max}}.$$

218 The constraint on s in the definition of the inverse of $h_{q,S}$ comes from the fact
 219 that we have to solve an equation of the form $\exp((\alpha_0 - s\alpha_{\max})/q) = g(y)$
 220 for a positive function g . Using (7) and (8), the size of the transition zones
 221 are finally

$$222 \quad |\mathcal{T}(h_{q,R}, \varepsilon, M)| := \mathcal{T}_R = q\alpha_{\max} \frac{(1+q)}{(\alpha_{\max}q + M)(\alpha_{\max}q + \varepsilon)} (M - \varepsilon),$$

$$223 \quad |\mathcal{T}(h_{q,S}, \varepsilon, M)| := \mathcal{T}_S = \frac{q}{\alpha_{\max}} \log \left(\frac{\alpha_{\max} - M(1 + \exp(-\alpha_0/q))}{\alpha_{\max} \exp(-\alpha_0/q) + M(1 + \exp(-\alpha_0/q))} \right)$$

$$224 \quad + \frac{q}{\alpha_{\max}} \log \left(\frac{\alpha_{\max} - \varepsilon(1 + \exp(-\alpha_0/q))}{\alpha_{\max} \exp(-\alpha_0/q) + \varepsilon(1 + \exp(-\alpha_0/q))} \right),$$

$$225 \quad |\mathcal{T}(h_{q,S,0}, \varepsilon, M)| := \mathcal{T}_{S,0} = \frac{q}{\alpha_{\max}} \log \left(\frac{(\alpha_{\max} - M)(\alpha_{\max} + \varepsilon)}{(\alpha_{\max} + M)(\alpha_{\max} - \varepsilon)} \right).$$

226 For $\alpha_0 = 0$, one can clearly see that $\mathcal{T}_{S,0} < \mathcal{T}_R$. To deal with the case $\alpha_0 > 0$,
 227 note that the parameter q is small since we wish the interpolation function to
 228 be close to an ideal step function. Also, we emphasize that $\alpha_0 > 0$ is going to
 229 depend on α_{\max} in order to control the percentage of fluid in Ω . Since α_{\max}
 230 has to be large enough, one gets that $z = \exp(-\alpha_0/q)$ is a small parameter

231 and we can thus expand \mathcal{T}_S as $z \rightarrow 0$. This gives

$$232 \quad \mathcal{T}_S = \frac{q}{\alpha_{\max}} \log \left(\frac{(\alpha_{\max} - M)(\alpha_{\max} - \varepsilon)}{M\varepsilon} \right) + O(\exp(-\alpha_0/q)),$$

233 from which one can see that $\mathcal{T}_S < \mathcal{T}_R$. Thanks to the factor q/α_{\max} , we can see
 234 that the intermediate zones of the sigmoid are in fact much smaller than those
 of the RAMP function. Some numerical calculation of the size of transition

	\mathcal{T}_R	\mathcal{T}_S	$\mathcal{T}_{S,0}$
$q = 1$	0.6657	0.0380	0.0055
$q = 10^{-4}$	0.1665	3.8002×10^{-6}	5.4881×10^{-7}
$q = 10^{-5}$	0.0196	3.8002×10^{-7}	5.4881×10^{-8}

Table 1: Size of the transition zones for $\alpha_{\max} = 200$, $M = \alpha_{\max}/2$, $\varepsilon = 0.1$ and $\alpha_0 = \alpha_{\max}/4$.

	\mathcal{T}_R	\mathcal{T}_S	$\mathcal{T}_{S,0}$
$q = 1$	0.6666	0.0050	5.4926×10^{-4}
$q = 10^{-4}$	0.6665	4.9517×10^{-7}	5.4926×10^{-8}
$q = 10^{-5}$	0.1666	4.9517×10^{-8}	5.4926×10^{-9}

Table 2: Size of the transition zones for $\alpha_{\max} = 2000$, $M = \alpha_{\max}/2$, $\varepsilon = 0.1$ and $\alpha_0 = \alpha_{\max}/4$.

235

236 zone confirming this fact can be found in Table 1,2 for $\alpha_{\max} \in \{200, 2000\}$
 237 and $q \in \{1, 10^{-4}, 10^{-5}\}$.

238 *3.3. Interpolation of the thermal conductivity*

239 The effective conductivity is interpolated using a sigmoid function similar
 240 to (4):

$$241 \quad k_\tau(\alpha, \alpha_0) = (k_s - k_f) \left(\frac{1}{1 + \exp(-\tau(\alpha - \alpha_0))} - \frac{1}{1 + \exp(\tau\alpha_0)} \right) + k_f \quad (9)$$

242 where $\alpha \in [0, \alpha_{\max}]$ is the design parameter, k_s and k_f are respectively the
 243 adimensional thermal diffusivity of the solid and of the fluid. Interpolation
 244 function (9) is again a smooth regularization of a Heaviside step function
 245 that satisfies $k_\tau(0, \alpha_0) = k_f$ together with the point-wise convergence

$$246 \quad \lim_{\tau \rightarrow +\infty} k_\tau(\alpha, \alpha_0) = \begin{cases} k_f & \text{if } \alpha < \alpha_0, \\ (k_f + k_s)/2 & \text{if } \alpha = \alpha_0, \\ k_s & \text{if } \alpha > \alpha_0. \end{cases}$$

247 Similarly to h_τ , the case $\alpha_0 = 0$ needs the following slight modification to
 248 still have, when $\tau \rightarrow +\infty$, a fluid-solid step function

$$249 \quad k_\tau(\alpha, 0) = \tilde{k}_\tau(\alpha) = 2(k_s - k_f) \left(\frac{1}{1 + \exp(-\tau\alpha)} - \frac{1}{2} \right) + k_f.$$

250 The previous function then satisfies $\tilde{k}_\tau(0) = 0$ and, for any $\alpha > 0$, $\tilde{k}_\tau(\alpha) \rightarrow k_s$
 251 as $\tau \rightarrow +\infty$. A RAMP-like interpolation function is also usually used for
 252 the thermal conductivity [30, 15]. Computations similar to those of Section
 253 3.2 can be done to prove that the transition zone of the sigmoid (9) are
 254 much smaller than those of the RAMP function hence motivating using such
 255 technique in topology optimization.

256 **4. Gradient computation with the adjoint model**

257 We chose to solve the optimization problem (1) with gradient-based op-
 258 timization algorithm. The latter requires the computation of the gradient
 259 of the cost functional with respect to the design variable which needs the
 260 sensitivities of the solution to the state equation with respect to α . To do
 261 this, we are going to use the adjoint method (see e.g. [24, 12, 45]) since it
 262 allows to compute the gradient of \mathcal{J} efficiently, only by solving the so-called
 263 direct problem (the governing equation) and the adjoint model.

264 We adopt here the *differentiate then discretize* approach [25] which means
 265 that we need to compute the continuous adjoint model associated to (1) as
 266 done in [17, 18]. The Lagrangian associated to the optimization problem (1)
 267 can then be defined as follows

$$\begin{aligned}
 \mathcal{L}((\mathbf{u}, \theta, p), (\mathbf{u}^*, \theta^*, p^*), \alpha) &:= \mathcal{J}(\mathbf{u}, \theta, p) - \int_{\Omega} p^* \operatorname{div} \mathbf{u} \, d\Omega \\
 &- \int_{\Omega} \mathbf{u}^* \cdot [(\mathbf{u} \cdot \nabla) \mathbf{u} + \nabla p - Re^{-1} \Delta \mathbf{u} + h_{\tau}(\alpha, \alpha_0) \mathbf{u} - Ri \theta \vec{e}_y] \, d\Omega \\
 &- \int_{\Omega} \theta^* \cdot [\nabla \cdot (\mathbf{u} \theta) - \operatorname{div}(Re^{-1} Pr^{-1} k_{\tau}(\alpha, \alpha_0) \nabla \theta)] \, d\Omega \\
 &- \int_{\Gamma_1} (\mathbf{u} \cdot \Phi_1 + (\partial_n \theta - 1) \psi_1) \, d\Gamma - \int_{\Gamma_2} (\mathbf{u} \cdot \Phi_2 + \partial_n \theta \psi_2) \, d\Gamma \\
 &- \int_{\Gamma_{\text{in}}} ((\mathbf{u} - \mathbf{u}_{\text{in}}) \cdot \Phi_{\text{in}} + \theta \psi_{\text{in}}) \, d\Gamma - \int_{\Gamma_{\text{out}}} (\partial_n \mathbf{u} \cdot \Phi_{\text{out}} + p q_{\text{out}} + \partial_n \theta \psi_{\text{out}}) \, d\Gamma
 \end{aligned} \tag{10}$$

268 where $(\mathbf{u}^*, \theta^*, p^*, \Phi_l, \psi_l, q_{\text{out}})$, for $l \in \{1, 2, \text{in}, \text{out}\}$, can be seen as Lagrange
 269 multiplier (or adjoint variables). We emphasize that the variables $(\Phi_l, \psi_l, q_{\text{out}})$
 270 are here to enforce the boundary conditions (3).
 271

272 The adjoint model is defined thanks to the critical point of \mathcal{L} with respect
 273 to the state variables (\mathbf{u}, θ, p) . We use below the following notation for the
 274 derivative of an application $\mathcal{F} : x \in \mathbf{E} \mapsto \mathcal{F}(x) \in \mathbf{F}$, where \mathbf{E}, \mathbf{F} are normed

275 spaces

$$276 \quad \frac{\partial \mathcal{F}}{\partial x}[\delta x] := \lim_{\varepsilon \rightarrow 0} \frac{\mathcal{F}(x + \varepsilon \delta x) - \mathcal{F}(x)}{\varepsilon}. \quad (11)$$

277 First, since \mathcal{L} is linear with respect to the adjoint variables, it is worth
 278 noting that we recover the state equation (2)-(3) if, for $l \in \{1, 2, \text{in}, \text{out}\}$, we
 279 solve

$$280 \quad \frac{\partial \mathcal{L}}{\partial(\mathbf{u}^*, \theta^*, p^*, \Phi_l, \psi_l, q_{\text{out}})}[\delta \mathbf{u}^*, \delta \theta^*, \delta p^*, \delta \Phi_l, \delta \psi_l, \delta q_{\text{out}}] = 0.$$

281 Using now (11) to differentiate the Lagrangian (10) with respect to the
 282 state variables, and integrating by parts to have no terms involving derivative
 283 of $(\delta \mathbf{u}, \delta \theta, \delta p)$, we end up with

$$\begin{aligned} \frac{\partial \mathcal{L}}{\partial(\mathbf{u}, \theta, p)}[\delta \mathbf{u}, \delta \theta, \delta p] &= \int_{\Omega} \frac{\partial \mathcal{J}_{\Omega}}{\partial(\mathbf{u}, \theta, p)}[\delta \mathbf{u}, \delta \theta, \delta p] d\Omega + \int_{\Gamma} \frac{\partial \mathcal{J}_{\Gamma}}{\partial(\mathbf{u}, \theta, p)}[\delta \mathbf{u}, \delta \theta, \delta p] d\Gamma + \\ &\int_{\Omega} \delta \mathbf{u} \cdot (\nabla p^* - h_{\tau}(\alpha, \alpha_0) \mathbf{u}^* - (\nabla \mathbf{u})^T \mathbf{u}^* + \nabla \mathbf{u}^* \mathbf{u} + \theta \nabla \theta^* + Re^{-1} \Delta \mathbf{u}^*) d\Omega \\ &+ \int_{\Omega} \delta \theta (\text{div}(Re^{-1} Pr^{-1} k_{\tau}(\alpha, \alpha_0) \nabla \theta^*) + \mathbf{u} \cdot \nabla \theta^* + Ri \mathbf{u}^* \cdot \mathbf{e}_y) d\Omega \\ &+ \int_{\Omega} \delta p \text{div} \mathbf{u}^* d\Omega - \int_{\Gamma} \delta p (\mathbf{u}^* \cdot \mathbf{n}) d\Gamma \\ &+ \int_{\Gamma} \delta \mathbf{u} \cdot (-n p^* - n \theta \theta^* + Re^{-1} \partial_n \mathbf{u}^* - (\mathbf{u} \cdot \mathbf{n}) \mathbf{u}^*) d\Gamma - \int_{\Gamma} Re^{-1} \partial_n \delta \mathbf{u} \cdot \mathbf{u}^* d\Gamma \\ &+ \int_{\Gamma} \delta \theta ((-\mathbf{u} \cdot \mathbf{n}) \theta^* - Re^{-1} Pr^{-1} k_{\tau}(\alpha, \alpha_0) \partial_n \theta^*) d\Gamma + \int_{\Gamma} \theta^* Re^{-1} Pr^{-1} k_{\tau}(\alpha, \alpha_0) \partial_n \delta \theta d\Gamma \\ &- \int_{\Gamma_1} (\delta \mathbf{u} \cdot \Phi_1 + \partial_n \delta \theta \psi_1) d\Gamma - \int_{\Gamma_2} (\delta \mathbf{u} \cdot \Phi_2 + \partial_n \delta \theta \psi_2) d\Gamma \\ &- \int_{\Gamma_{\text{in}}} (\delta \mathbf{u} \cdot \Phi_{\text{in}} + \delta \theta \psi_{\text{in}}) d\Gamma - \int_{\Gamma_{\text{out}}} (\partial_n \delta \mathbf{u} \cdot \Phi_{\text{out}} + \delta p q_{\text{out}} + \partial_n \delta \theta \psi_{\text{out}}) d\Gamma \end{aligned} \quad (12)$$

284

285 Assuming that $(\delta \mathbf{u}, \delta \theta, \delta p, \Phi_l, \psi_l, q_{\text{out}}) = 0$ for $l \in \{1, 2, \text{in}, \text{out}\}$, that the first
 286 derivatives of $\delta \mathbf{u}, \delta \theta$ vanish on Γ and solving $(\partial \mathcal{L} / \partial(\mathbf{u}, \theta, p))[\delta \mathbf{u}, \delta \theta, \delta p] = 0$

287 yield the adjoint problem:

$$\begin{aligned}
\nabla p^* - h_\tau(\alpha) \mathbf{u}^* + \theta \nabla \theta^* + Re^{-1} \Delta \mathbf{u}^* + \nabla \mathbf{u}^* \cdot \mathbf{u} - (\nabla \mathbf{u})^T \mathbf{u}^* &= -\frac{\partial \mathcal{J}_\Omega}{\partial \mathbf{u}} & \text{in } \Omega \\
\operatorname{div} \mathbf{u}^* &= -\frac{\partial \mathcal{J}_\Omega}{\partial p} & \text{in } \Omega \\
Ri \mathbf{u}^* \cdot \vec{e}_y + \mathbf{u} \cdot \nabla \theta^* + \operatorname{div} (Re^{-1} Pr^{-1} k_\tau(\alpha) \nabla \theta^*) &= -\frac{\partial \mathcal{J}_\Omega}{\partial \theta} & \text{in } \Omega.
\end{aligned} \tag{13}$$

288

289 For the adjoint boundary condition, we are going to show how to obtain
290 them on $\Gamma_1 \cup \Gamma_2$ since the other part of Γ can be done in the same spirit.

291 On both walls, the primal velocity is fixed to zero (no-slip condition on the
292 walls) and the heat flux either vanishes or is constant. Since $\operatorname{div} \mathbf{u} = 0$ and
293 \mathbf{u} is prescribed or null value, there will be $\delta \mathbf{u} = 0$, $\operatorname{div} \delta \mathbf{u} = 0$ and $\partial_n \delta \theta = 0$.

294 We recall a formula from [11, Lemma 7] that holds for any vector fields \mathbf{w}
295 and reads

$$296 \quad \partial_n \mathbf{w} \cdot n = \operatorname{div} \mathbf{w}|_\Gamma - \operatorname{div}_\Gamma \mathbf{w}_t - \kappa \mathbf{w} \cdot n, \tag{14}$$

297 where $\kappa = \operatorname{div} n$ is the curvature of Γ and $\operatorname{div}_\Gamma$ is the surface divergence
298 operator. Since $\partial_n \delta \mathbf{u} \cdot \mathbf{u}^* = (\partial_n \delta \mathbf{u})_n \cdot u_n^* + (\partial_n \delta \mathbf{u})_t \cdot u_t^*$ and $\delta \mathbf{u} = 0$ and
299 $\operatorname{div} \delta \mathbf{u} = 0$, formula (14) gives that

$$300 \quad \partial_n \delta \mathbf{u} \cdot \mathbf{u}^* = (\partial_n \delta \mathbf{u})_t \cdot u_t^*.$$

301 The boundary conditions on $\Gamma_1 \cup \Gamma_2$ are then obtained from (12) by consid-
302 ering, for $l = 1, 2$, the following vanishing terms

$$\begin{aligned}
\int_{\Gamma_l} Re^{-1} \partial_n \delta \mathbf{u} \cdot \mathbf{u}^* d\Gamma &= \int_{\Gamma} Re^{-1} (\partial_n \delta \mathbf{u})_t \cdot u_t^* d\Gamma = 0, \\
\int_{\Gamma_l} \delta p \left(\mathbf{u}^* \cdot n - \frac{\partial \mathcal{J}_\Gamma}{\partial p} \right) d\Gamma &= 0, \\
\int_{\Gamma_l} \delta \theta \left((-\mathbf{u} \cdot n) \theta^* - Re^{-1} Pr^{-1} k_\tau(\alpha, \alpha_0) \partial_n \theta^* + \frac{\partial \mathcal{J}_\Gamma}{\partial \theta} \right) d\Gamma &= 0.
\end{aligned} \tag{15}$$

303 The adjoint boundary conditions on Γ_{in} are obtained as above by taking
 304 $\delta\theta = 0$. For the outlet, we use $\partial_n\delta\theta = 0$, $\partial_n\delta\mathbf{u} = 0$ and $\delta p = 0$. Finally, we
 305 end up with the adjoint boundary condition

$$\begin{aligned}
 \text{On } \Gamma_1 \cup \Gamma_2 : \quad & u_t^* = 0, \quad u_n\theta^* + Re^{-1}Pr^{-1}k_\tau(\alpha, \alpha_0) \partial_n\theta^* = \frac{\partial\mathcal{J}_\Omega}{\partial\theta}, \quad u_n^* = \frac{\partial\mathcal{J}_\Omega}{\partial p}, \\
 \text{On } \Gamma_{in} : \quad & u_n^* = \frac{\partial\mathcal{J}_\Gamma}{\partial p} \quad u_t^* = 0, \quad \theta^* = 0, \\
 \text{On } \Gamma_{out} : \quad & u_n \theta^* + Re^{-1}Pr^{-1}k_\tau(\alpha, \alpha_0) \partial_n\theta^* = \frac{\partial\mathcal{J}_\Gamma}{\partial\theta}, \\
 & n p^* + n \theta \theta^* + Re^{-1}\partial_n u^* + u_n \mathbf{u}^* = \frac{\partial\mathcal{J}_\Gamma}{\partial\mathbf{u}}.
 \end{aligned}
 \tag{16}$$

306

307 Now solving $(\partial\mathcal{L}/\partial\alpha)[\delta\alpha] = 0$ for all $\delta\alpha$ yields

$$\begin{aligned}
 \frac{\partial h_{\tau, \alpha_0}}{\partial\alpha} \mathbf{u} \cdot \mathbf{u}^* + Re^{-1}Pr^{-1} \frac{\partial k_{\tau, \alpha_0}}{\partial\alpha} \nabla\theta \cdot \nabla\theta^* &= 0 \quad \text{in } \Omega \\
 \frac{\partial k_{\tau, \alpha_0}}{\partial\alpha} \theta^* &= 0 \quad \text{on } \Gamma_1,
 \end{aligned}
 \tag{17}$$

308

309 which is the optimality condition. Finally, according to the adjoint method
 310 (see e.g. [24, 12, 25]), the gradient of the cost functional $\mathcal{J}(\mathbf{u}, \theta, p)$ at some
 311 α is given by

$$\begin{aligned}
 \frac{\partial\mathcal{J}}{\partial\alpha}(\alpha) &= \frac{\partial h_{\tau, \alpha_0}}{\partial\alpha} \mathbf{u} \cdot \mathbf{u}^* + Re^{-1}Pr^{-1} \frac{\partial k_{\tau, \alpha_0}}{\partial\alpha} \nabla\theta \cdot \nabla\theta^*, \quad \text{in } \Omega, \\
 \frac{\partial\mathcal{J}}{\partial\alpha}(\alpha) &= \frac{\partial k_{\tau, \alpha_0}}{\partial\alpha} \theta^* \quad \text{on } \Gamma_1,
 \end{aligned}
 \tag{18}$$

312

313 where (\mathbf{u}, θ, p) satisfy (2-3) and $(\mathbf{u}^*, \theta^*, p^*)$ satisfy the adjoint problem (13-
 314 16).

315 **Remark 1.** *The adjoint variables $(\Phi_l, \psi_l, p_{out})$ used to enforce the boundary*
 316 *conditions (3) of the primal problem are not needed to solve the adjoint prob-*
 317 *lem. Nevertheless, they can be determined using (13,15) which cancel many*

318 *terms in (12) and gives*

$$\begin{aligned}
319 \quad \Phi_l &= -n p^* - n \theta \theta^* + Re^{-1} \partial_n \mathbf{u}^* - (\mathbf{u} \cdot \mathbf{n}) \mathbf{u}^* + \frac{\partial \mathcal{J}_\Gamma}{\partial \mathbf{u}} \text{ on } \Gamma_l \\
320 \quad \psi_l &= \theta^* Re^{-1} Pr^{-1} k_\tau(\alpha, \alpha_0) + \frac{\partial \mathcal{J}_\Gamma}{\partial \theta} \text{ on } \Gamma_l, l \in \{1, 2, \text{in}\}, \\
321 \quad \Phi_{\text{out}} &= -Re^{-1} \mathbf{u}^*, \psi_{\text{out}} = \theta^* Re^{-1} Pr^{-1} k_\tau(\alpha, \alpha_0), q_{\text{out}} = -u_n^* - \frac{\partial \mathcal{J}_\Gamma}{\partial p}.
\end{aligned}$$

322 *Note finally that these adjoint variables are also not needed to compute the*
323 *gradient of the cost functional with respect to the design variable since they*
324 *does not appear in (18).*

325 5. Numerical example

326 This section aims to validate the new interpolation technique. To do so,
327 we investigate two objective functions. First objective function is related to
328 the power dissipated by the fluid through the domain Ω and can be evaluated
329 on the basis of total pressure losses as follows:

$$330 \quad \mathcal{J}_1(\mathbf{u}, p, \theta) = - \int_\Gamma p_t \mathbf{u} \cdot \mathbf{n} d\Gamma \quad \text{where } p_t = p + \frac{1}{2} \mathbf{u}^2 \quad (19)$$

331 The second cost function is related to the maximization of the recoverable
332 thermal power from the domain Ω and is given by

$$333 \quad \mathcal{J}_2(\mathbf{u}, p, \theta) = \int_\Gamma \theta \mathbf{u} \cdot \mathbf{n} d\Gamma \quad (20)$$

334 We finally consider the following objective functional

$$\begin{aligned}
\text{minimize:} \quad \mathcal{J}(\mathbf{u}, p, \theta) &= \mathcal{J}_1(\mathbf{u}, p, \theta) - \mathcal{J}_2(\mathbf{u}, p, \theta), \\
&= - \int_\Gamma (p_t + \theta) \mathbf{u} \cdot \mathbf{n} d\Gamma
\end{aligned} \quad (21)$$

335 subject to: Governing equation (2),
Boundary conditions (3).

336 We notice that the objective function \mathcal{J} is a linear combination of both
337 objective functions described above. It's taking place at the inlet and outlet
338 flow boundary conditions and the combination involves the opposite of \mathcal{J}_2
339 since the optimization problem aims at minimizing the combinatory function
340 \mathcal{J} . Using the notation from the general optimization problem (1), we have
341 $\mathcal{J}_\Omega = 0$ and $\mathcal{J}_\Gamma(\mathbf{u}, p, \theta) = (p + \theta) \mathbf{u} \cdot \mathbf{n}$. The adjoint model is then given by
342 (13)-(16) where all the partial derivative of \mathcal{J}_Ω are zero and the following
343 boundary conditions hold

$$\begin{aligned}
& \mathbf{u}^* = \mathbf{0}, \quad \partial_n \theta^* = 0 && \text{on } \Gamma_1 \cup \Gamma_2, \\
& u_t^* = 0, \quad \theta^* = 0, \quad u_n^* = -u_n && \text{on } \Gamma_{in}, \\
& \theta^* u_n + Re^{-1} Pr^{-1} k_\tau(\alpha) \partial_n \theta^* = -u_n && \text{on } \Gamma_{out}, \\
& p^* + \theta^* \theta + Re^{-1} \nabla_n \mathbf{u}^* \cdot \mathbf{n} + u_n^* u_n = -(\theta + p) && \text{on } \Gamma_{out}.
\end{aligned} \tag{22}$$

345 As said in section 4, we propose to solve the topology optimization problem
346 with a steepest descent algorithm where the gradient is computed thanks to
347 the adjoint method. The main flow of the algorithm for the topology opti-
mization is described in Table 3. The forward problem and the optimization

Step 0. Initialization: set all the constants Re, Ri, Pr
Step 1. Solve the forward problem (2),(3) problem with the Finite Volume Method
Step 2. Compute objective and constraint values
Step 3. Compute sensitivities by adjoint method
Step 4. Evaluate the optimality condition. If a stopping criterion is met, terminate the calculation
Step 5. Update design variables α with $\alpha_{k+1} = -\nabla \mathcal{J}_{k+1} + \beta_{k+1}^{PR} \alpha_k$ and return to step 1

Table 3: Algorithm of topology optimization

348

349 processes are implemented using OpenFOAM [44]. In Step 5, the design

350 variables are evaluated by using the conjugated-gradient descent direction
351 method associated to Polack-Ribiere method $\beta_{k+1}^{PR} = \frac{\nabla \mathcal{J}_{k+1}^T (\nabla \mathcal{J}_{k+1} - \nabla \mathcal{J}_k)}{\nabla \mathcal{J}_k^T \nabla \mathcal{J}_k}$.

352 After optimization process, several results are compared as optimized de-
353 signs, velocity magnitude distribution, temperature distribution, and lastly,
354 we focus on fluid-solid interfaces. We also presents the objective function
355 values for each simulation case. Finally, we investigate to vary the slope
356 abscissa and the curve of sigmoid functions in order to evaluate their impact
357 on the optimization problem. That corresponds to consider different values
358 of α_0 and τ . In our study, α_0 will vary in $\{25, 50, 100\}$ which correspond re-
359 spectively to $\{\alpha_{max}/8, \alpha_{max}/4, \alpha_{max}/2\}$ and τ will vary in $\{0.3, 0.7, 1.0\}$. In
360 order to perform topology optimization, the α term may take a finite value
361 between 0 and $\alpha_{max} = 200$.

362 5.1. Studied Cases

363 Two representative cases of topology optimization in fluid dynamics are
364 investigated : the single pipe case and the bend pipe case. Figure 2 shows
365 schematic illustrations of the two studied cases.

366 5.1.1. Design of a single pipe.

367 We present here a benchmark numerical example used recently by Marck
368 [15] to illustrate the viability and efficiency of the methodology presented in
369 this paper. The design domain consists in a cavity of side L . The compu-
370 tational domain is discretized using 100×100 elements. The inlet flow is
371 located in the center of the west edge for a length of $L/5$. The outlet flow
372 is lining up with it on the east edge. The rest of west and east edges are
373 assumed to be adiabatic and will be called Γ_2 , whereas the whole north and

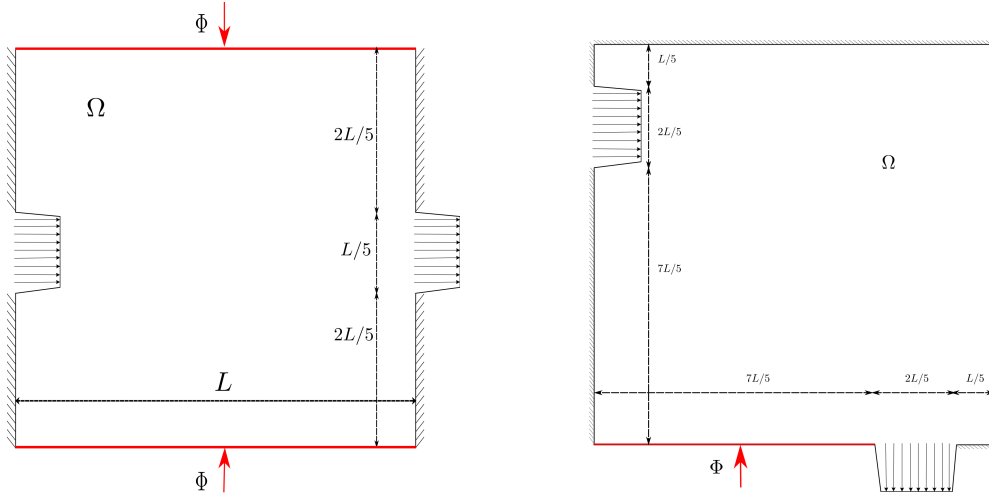

Figure 2: Single pipe and Bend pipe

374 south walls are subjected to a constant flux of temperature, called thereafter
 375 Γ_1 .

376 *5.1.2. Design of a bend pipe.*

377 The second example has been studied by several authors as [4] and [15].
 378 The computational domain is also square-shaped, with a adimensional side
 379 $L = 1$, and the design grid is made of 100×100 elements. The inlet flow
 380 is located at $L/5$ of the west edge. The outlet flow is located on the south
 381 edge, at $L/5$ from the east edge. The length of both flow boundary conditions
 382 is set to $2L/5$. The part of the south edge located on the left of the outlet
 383 is subjected to a constant flux of temperature and will be called Γ_1 . The rest
 384 of the edges are assumed to be adiabatic and will be designated as Γ_2 .

385 *5.1.3. Physical parameters.*

386 For the two representative cases studied in this section, the inlet flow
 387 is prescribed with a constant horizontal velocity equal to $U_0 = 0.04 \text{ m.s}^{-1}$

388 used in Reynolds number. The inlet temperature is fixed to $\theta = 0$. The
 389 outflow temperature condition is fixed to a zero gradient, as well as the
 390 velocity gradient. Hot walls are subject to a constant flux of temperature
 391 $\partial_n \theta = -1$. The Reynolds number based on the characteristic dimension of
 392 the inlet length and the average inlet velocity is $Re = 500$. The Rayleigh
 393 number is fixed to $Ra = 5 \times 10^5$. Prandtl number is set to 0.71. Grashof
 394 number has the following expression $Gr = Ra/Pr$. Adimensional thermal
 395 parameters are the following: $k_s = (9.88 \times 10^{-5} \text{ m}^2 \cdot \text{s}^{-1}) / (2.25 \times 10^{-5} \text{ m}^2 \cdot \text{s}^{-1})$
 396 [(Aluminum/Air) Diffusivities], $k_f = 1$.

397 5.2. Results

398 The aim of the problems defined above is to determine the optimal design
 399 that connects the inlet to the outlet of the cavity and that minimizes the
 400 objective function \mathcal{J} subjected to the constraints (2) and (3).

401 First of all, we compute \mathcal{J} without optimization for the two studied
 402 cases and we obtained respectively for the single pipe $J = 9.07 \cdot 10^{-3}$ and for
 403 the bend pipe $J = 6.38 \cdot 10^{-3}$. Compared to values issued from optimization
 404 process and referenced in Figure 8 and 11, they are reduced between 23% and
 405 42% for the single pipe case, and between 18% and 19% for the bend pipe.
 406 So, the new method investigated here allows to both minimize the power
 407 dissipated by the fluid through the domain Ω and maximize the recoverable
 408 thermal power from the domain to the fluid.

409 Secondly, we plot velocity magnitude for various α_0 and τ values. After
 410 optimization of \mathcal{J} in the single pipe, we obtain an optimized design in which
 411 fluid is transported through the single pipe in a straight pipe (see Figure 3). It
 412 is quite closed to the optimized design obtained by [15] when the mechanical

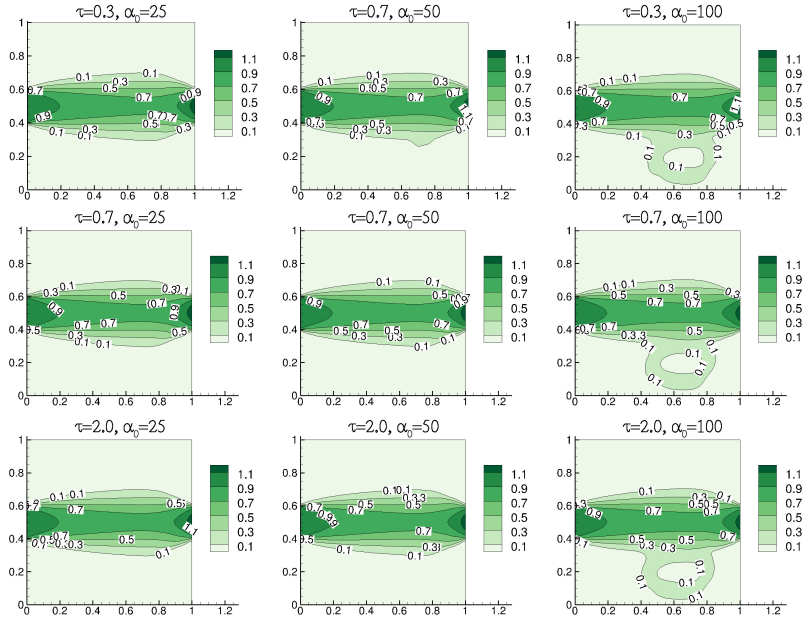

Figure 3: Velocity magnitude distribution in the single pipe

413 power and thermal power are considered with the same weighting coefficient.
 414 Similarly, fluid circulation forms a half circle whose center would be the left
 415 bottom corner of the square domain in the optimized bend pipe (see Figure
 416 4). Contrary to the literature in fluid mechanics, the optimized path obtained
 417 for the flow is not as straight as possible. It can be explained by the fact that
 418 we consider here a heat transfer problem. So, the optimized pipe is larger
 419 and form a real bend because the fluid flow moves away from hot regions.

420 Thereafter, we compared distribution of the parameter α in the domain
 421 for the two studied cases (see Figures 6 and 9). We recall that values less
 422 than α_0 are considered as fluid regions. We can notice that this method
 423 based on α_0 affected some values of α to the fluid regions, which would not
 424 be possible with other methods of the literature. Indeed, generally with the

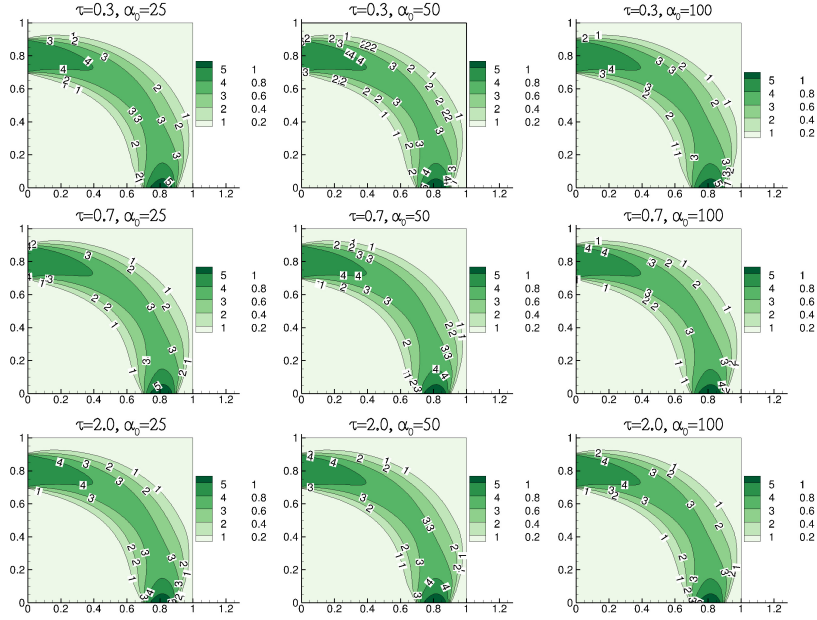

Figure 4: Velocity magnitude distribution in the bend pipe

425 function (6), only value of α equal to zero is considered as fluid element. As
 426 can be seen on these figures, intermediate values for the fluid region exist.
 427 For example, we have different values of α between 0 and α_0 at right-top
 428 corner in Figure 9, or below the straight pipe for $\alpha_0 = 25$ in Figure 6.

429 As expected, the interpolation function $h_\tau(\alpha)$ suppresses these intermedi-
 430 ate values noticed previously and affects these volume elements to pure fluid
 431 volume elements. Indeed, Figures 7 and 10 show the optimized designs for
 432 various α_0 and τ numbers. Compared to α distribution (Figures 6 and 9),
 433 they demonstrate that the interpolation function $h_\tau(\alpha)$ suppresses interme-
 434 diate values corresponding neither to pure fluid nor to pure solid regions by
 435 affecting them to solid regions or fluid regions. However, in the bend pipe, a
 436 porous domain still exists near hot regions. Although fluid does not circulate

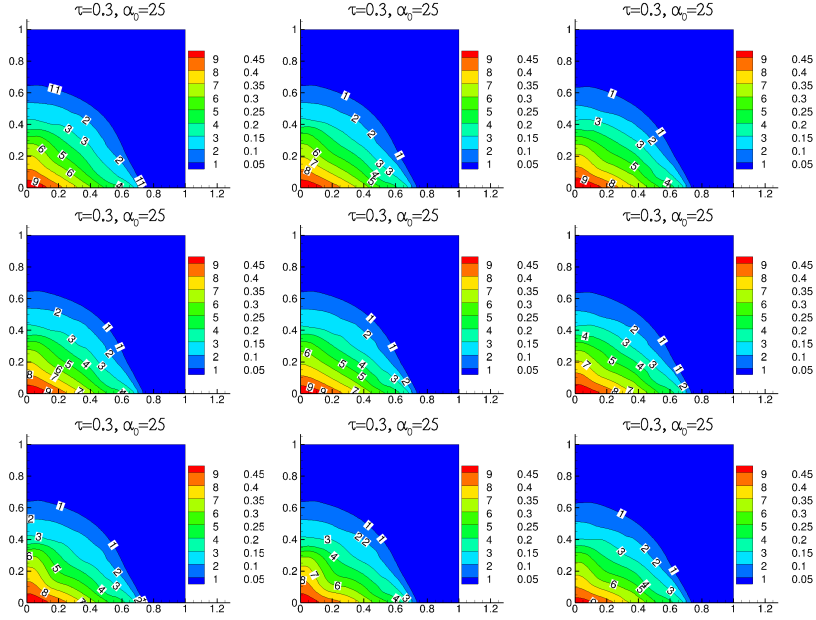

Figure 5: Temperature distribution in the bend pipe

437 in this porous domain, its existence contributes to increasing thermal power
 438 recovered by the fluid. That is illustrated in Figure 5.

439 At last, it can be seen that thermal conductivity is well distributed, con-
 440 tinuously, between fluid and solid regions. Figure 8 represents the distri-
 441 bution of material conductivity after the optimization process in the single
 442 pipe case. Compared to Figure 7, we observe that frontier between the two
 443 regions, fluid and solid, is well-established. For the bend pipe case, although
 444 intermediate regions exist, k_τ interpolation function allows to affect to this
 445 porous domain a conductivity closed to the fluid diffusivity (see Figure 11).
 446 Therefore, the function $k_\tau(\alpha)$ provides a continuous transition between the
 447 solid and the fluid domains.

448 5.2.1. Influence of α_0 .

449 It can clearly be seen from Figures 7 and 10 that different designs are ob-
 450 tained for the different values of α_0 . As detailed in section 3, α_0 is depending
 451 of α_{max} in order to control the percentage of fluid in Ω . This parameter has
 452 a significant impact on the quantity of material adding in the domain and
 453 that can be illustrated by computing the proportion Q_t of material added in
 454 the domain Ω as follows :

$$455 \quad Q_t = \frac{\int_{\Omega} h_{\tau}(\alpha) d\Omega}{\alpha_{max} V_{tot}} \text{ where } V_{tot} \text{ is the total volume of } \Omega \quad (23)$$

456 Calculation results are referenced in Figures 7 and 10. In the single pipe,
 457 when α_0 increases, quantity of material diminishes between 27.5% and 28%.
 458 That means fluid domain is more important and that contributes to the
 459 increase of \mathcal{J}_2 . So, that will influence the value of \mathcal{J} . In the bend pipe,
 460 when α_0 increases, quantity of material also diminishes between 3.6% and
 461 16%. So, fluid domain is relatively more important than solid domain but
 462 not enough to significantly impact on the value of \mathcal{J} , hence, the small effect
 463 on values of \mathcal{J} (see Figure 11). So, parameter α_0 has a significant incidence
 464 on the proportion of fluid domain relatively to solid domain and therefore,
 465 can influence the value of the functional objective.

466 Futhermore, we observe a recirculation zone for $\alpha_0 = 100$ in the example
 467 of the optimized single pipe (see Figure 3). That can also be explained by
 468 the value of α_0 . Indeed, larger α_0 means that the proportion of fluid elements
 469 compared to α_{max} is bigger and thus fluid regions are more important. When
 470 $\alpha_0 = 100$, that means $\alpha_0 = \alpha_{max}/2$, the algorithm affects some value of
 471 $\alpha \in [0, 100]$ corresponding to fluid domain and so impacts on the size of fluid
 472 regions relatively to the solid regions in the domain.

473 *5.2.2. Influence of τ .*

474 It can clearly be seen from Figures 7 and 10 that different designs are
475 obtained for the different values of τ . The parameter τ in the interpolation
476 functions $h_\tau(\alpha)$ and k_τ indicates the stiffness of the curve of the functions. It
477 does not seem to impact significantly the optimization results. However, we
478 can observe in Figure 11 that the frontier between the fluid and the solid is
479 sharper when $\tau = 2.0$. In Figure 8, for $\tau = 0.3$, $\tau = 0.7$, we can notice residual
480 material in fluid domain while they do not exist anymore when $\tau = 2.0$. As
481 the same, the porous region identified in the bend pipe case between the
482 main flow and the hot plate is defined mostly with the fluid diffusivity by the
483 interpolation function. This impact does not influence significantly the result
484 of the optimization computation when we compared their value in Figure 11
485 but it improves the thermal transition between fluid and solid regions. So,
486 parameter τ seems to improve the thermal conductivity distribution during
487 the process optimization.

488 **6. Conclusion**

489 This study shows that the new interpolation technique based on sigmoid
490 function is a viable method. Design material is well interpolated since inter-
491 mediate regions between solid and fluid are suppressed hence giving a frontier
492 between the two regions which is well-defined. Besides, the size of transition
493 zones between fluid and solid regions is explicitly computed. The result is
494 that the new interpolation functions reduce their size comparatively to the
495 RAMP interpolation function. Therefore, the transition between fluid and
496 solid is improving thanks to this sigmoid function for the effective conduc-

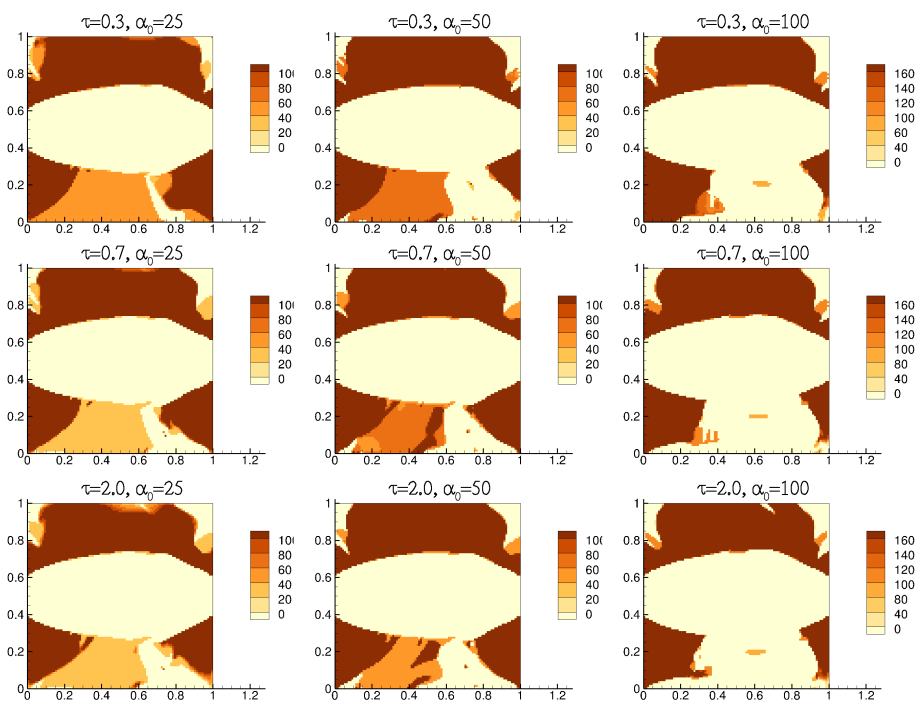

Figure 6: α distribution in the single pipe

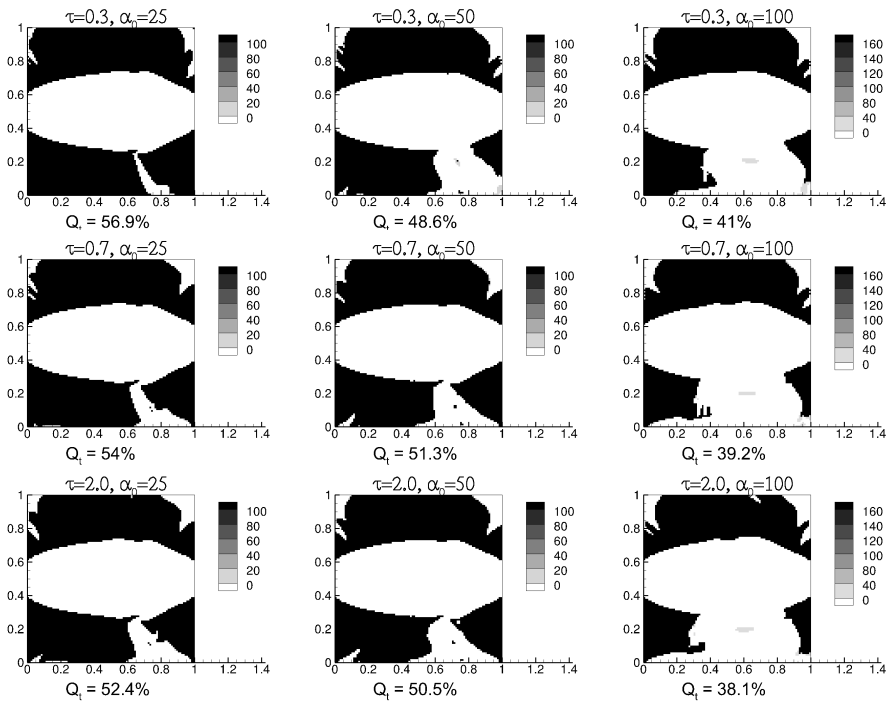

Figure 7: $h_\tau(\alpha)$ distribution in the single pipe and proportion of material Q_t added in the domain after optimization

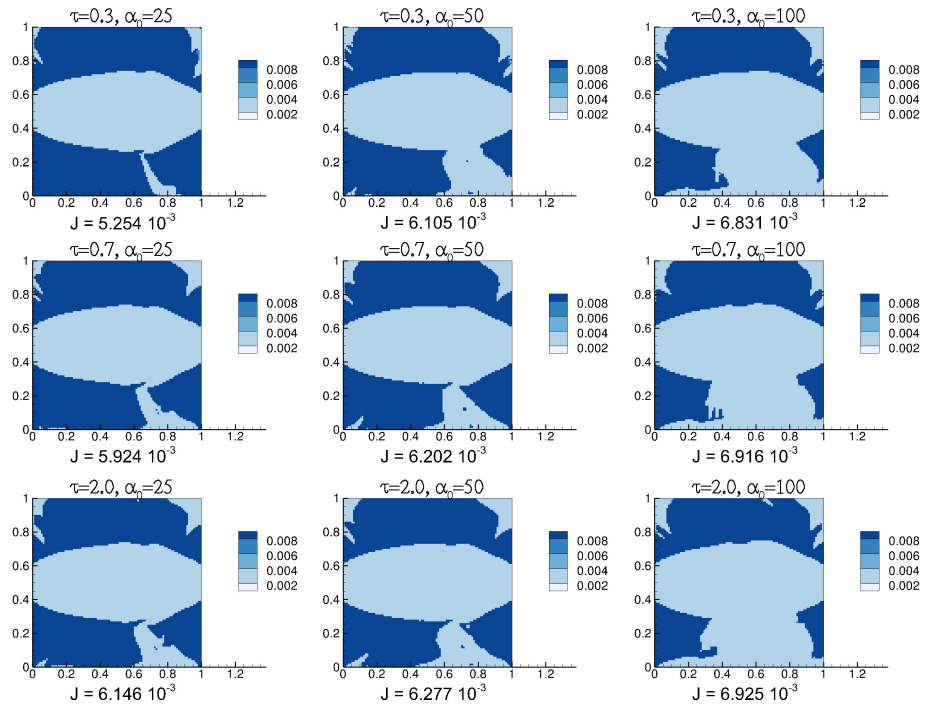

Figure 8: $k_\tau(\alpha)$ distribution in the single pipe for different values of τ and α_0 and value of functional objectif \mathcal{J} after optimization

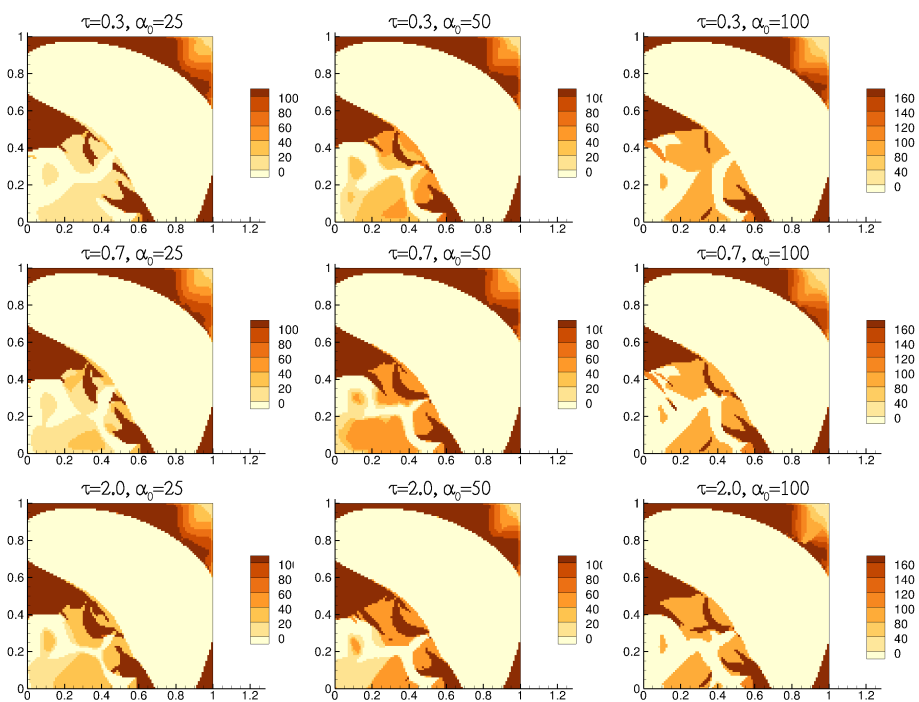

Figure 9: α distribution in the bend pipe

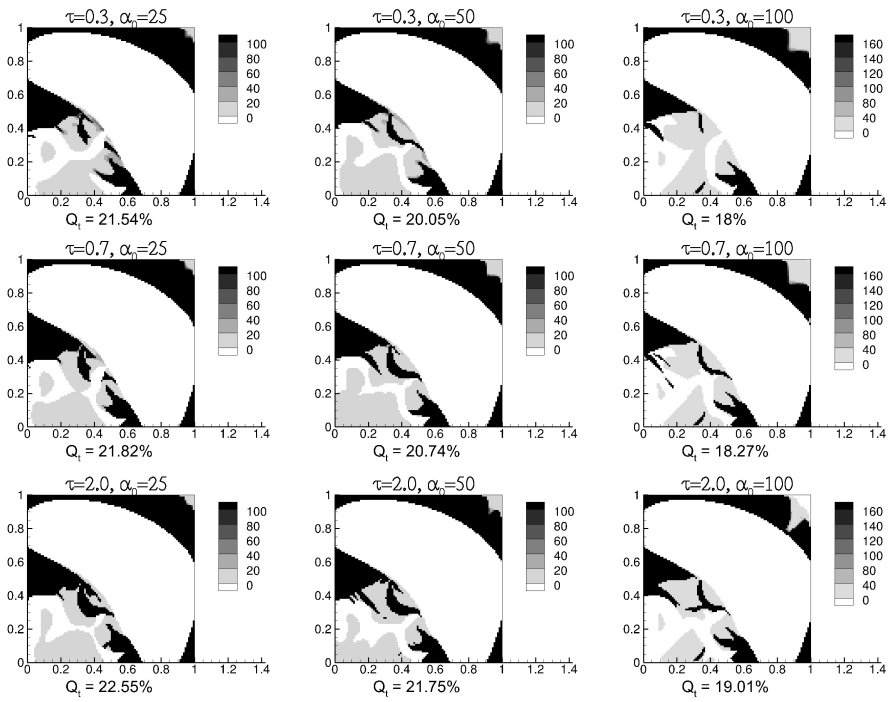

Figure 10: $h_\tau(\alpha)$ distribution in the bend pipe and proportion of material Q_t added in the domain after optimization

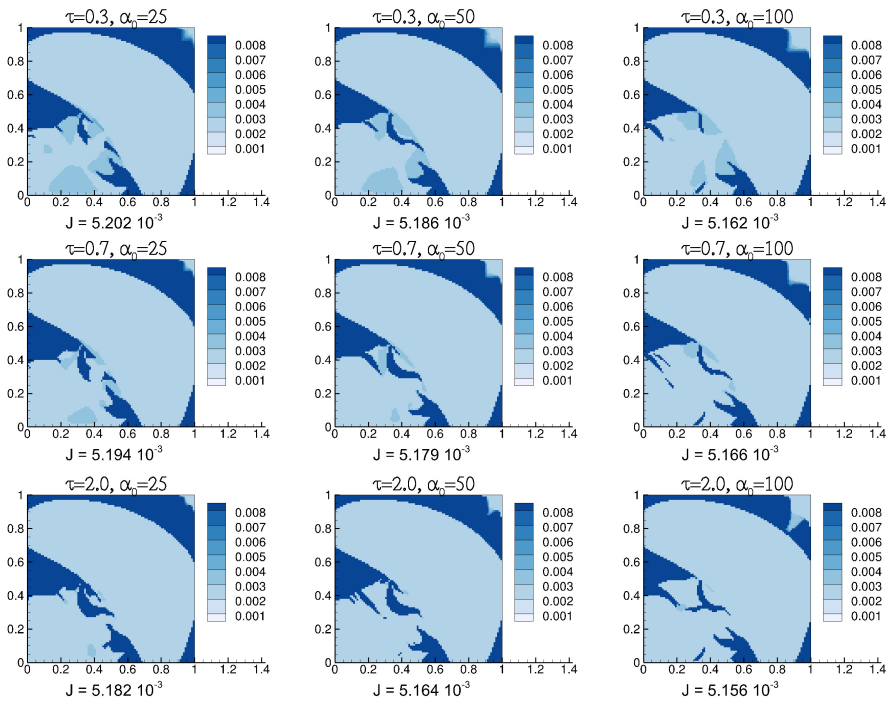

Figure 11: $k_\tau(\alpha)$ distribution in the bend pipe and value of functional objective \mathcal{J} after optimization

497 tivity. Computation of the size of transition zones could also be applied to
498 other interpolation functions in order to evaluate the well-definition of the
499 frontier between fluid and solid regions. This new interpolation technique do
500 not require any regularization techniques since no checkerboards have been
501 identified for the two studied cases. Two new parameters have been intro-
502 duced : the abscissa slope of the sigmoid function α_0 and the curve of the
503 sigmoid function τ . Their impact has been also investigated. α_0 has a sig-
504 nificant impact on the quantity of material added in the domain during the
505 optimization process. The larger α_0 is the bigger will be the fluid domain.
506 The parameter τ has a small impact on the results of optimization. For the
507 studied cases, the impact was seen after interpolation of thermal conduc-
508 tivity. Elements of porous domain have been affected to fluid diffusivity or
509 solid conductivity, and therefore, the thermal transition between material is
510 improved. So, this study has examined a new interpolation technique to deal
511 with fluid-porous media interfaces for topology optimization of heat transfer
512 problems. Further research might explore several type of flow regimes in
513 optimization problems using these interpolation functions. Another possible
514 area of future research would be to investigate new cost functions.

515 **References**

- 516 [1] Bendsøe, Martin Philip, and Ole Sigmund. Topology optimization: the-
517 ory, methods, and applications. Springer Science & Business Media,
518 2013.
- 519 [2] Guest, James K., and Jean H. Prvost. "Topology optimization of creep-

- 520 ing fluid flows using a DarcyStokes finite element." International Journal
521 for Numerical Methods in Engineering 66.3 (2006): 461-484.
- 522 [3] Kreissl, Sebastian, Georg Pingen, and Kurt Maute. "Topology optimiza-
523 tion for unsteady flow." International Journal for Numerical Methods in
524 Engineering 87.13 (2011): 1229-1253.
- 525 [4] Borrvall, Thomas, and Joakim Petersson. "Topology optimization of
526 fluids in Stokes flow." International journal for numerical methods in
527 fluids 41.1 (2003): 77-107.
- 528 [5] Kreissl, Sebastian, and Kurt Maute. "Levelset based fluid topology op-
529 timization using the extended finite element method." Structural and
530 Multidisciplinary Optimization 46.3 (2012): 311-326.
- 531 [6] Rozvany, George IN, Ming Zhou, and Torben Birker. "Generalized shape
532 optimization without homogenization." Structural and Multidisciplinary
533 Optimization 4.3 (1992): 250-252.
- 534 [7] Lee, Kyungjun, PhD thesis, University of Michigan, Topology Optimiza-
535 tion of Convective Cooling System Designs, 2012
- 536 [8] Olesen, Laurits H., Fridolin Okkels, and Henrik Bruus. "A high-
537 level programming-language implementation of topology optimiza-
538 tion applied to steady-state Navier-Stokes flow." arXiv preprint
539 physics/0410086 (2004).
- 540 [9] Gersborg-Hansen, Allan, Ole Sigmund, and Robert B. Haber. "Topol-
541 ogy optimization of channel flow problems." Structural and Multidisci-
542 plinary Optimization 30.3 (2005): 181-192.

- 543 [10] Gersborg, Allan Roulund, and Casper Schousboe Andreasen. "An ex-
544 plicit parameterization for casting constraints in gradient driven topol-
545 ogy optimization." *Structural and Multidisciplinary Optimization* 44.6
546 (2011): 875-881.
- 547 [11] Kangro, Urve, and Roy Nicolaides. "Divergence boundary conditions
548 for vector Helmholtz equations with divergence constraints." *ESAIM:
549 Mathematical Modelling and Numerical Analysis* 33.3 (1999): 479-492.
- 550 [12] Petra, Noei, and Georg Stadler. Model variational inverse problems gov-
551 erned by partial differential equations. No. ICES-11-05. Texas univ. at
552 Austin inst. for computational engineering and sciences, 2011
- 553 [13] van Dijk, Nico P., et al. "Level-set methods for structural topology opti-
554 mization: a review." *Structural and Multidisciplinary Optimization* 48.3
555 (2013): 437-472.
- 556 [14] Evgrafov, Anton. "The limits of porous materials in the topology op-
557 timization of Stokes flows." *Applied mathematics & optimization* 52.3
558 (2005): 263-277.
- 559 [15] Marck, Gilles, Maroun Nemer, and Jean-Luc Harion. "Topology opti-
560 mization of heat and mass transfer problems: laminar flow." *Numerical
561 Heat Transfer, Part B: Fundamentals* 63.6 (2013): 508-539.
- 562 [16] Stolpe, Mathias, and Krister Svanberg. "An alternative interpolation
563 scheme for minimum compliance topology optimization." *Structural and
564 Multidisciplinary Optimization* 22.2 (2001): 116-124.

- 565 [17] Qian, Xiaoping, and Ercan M. Dede. "Topology optimization of a cou-
566 pled thermal-fluid system under a tangential thermal gradient con-
567 straint." *Structural and Multidisciplinary Optimization* 54.3 (2016):
568 531-551.
- 569 [18] Othmer, C. "A continuous adjoint formulation for the computation of
570 topological and surface sensitivities of ducted flows." *International Jour-
571 nal for Numerical Methods in Fluids* 58.8 (2008): 861-877.
- 572 [19] Matsumori, T., A. Kawamoto, and T. Kondoh. "Topology optimiza-
573 tion for fluidthermal interaction problems." 6th ChinaJapanKorea joint
574 symposium on optimization of structural and mechanical systems. 2010.
- 575 [20] Dede, Ercan M. "Multiphysics optimization, synthesis, and application
576 of jet impingement target surfaces." *Thermal and Thermomechanical
577 Phenomena in Electronic Systems (ITherm)*, 2010 12th IEEE Intersoci-
578 ety Conference on. IEEE, 2010.
- 579 [21] Dede, Ercan M. "Multiphysics topology optimization of heat transfer
580 and fluid flow systems." *proceedings of the COMSOL Users Conference*.
581 2009.
- 582 [22] Amir, Oded, and Ole Sigmund. "On reducing computational effort in
583 topology optimization: how far can we go?." *Structural and Multidisci-
584 plinary Optimization* 44.1 (2011): 25-29.
- 585 [23] Kim, Yoon Young, and Gil Ho Yoon. "Multi-resolution multi-scale topol-
586 ogy optimizationa new paradigm." *International Journal of Solids and
587 Structures* 37.39 (2000): 5529-5559.

- 588 [24] Herzog, Roland, and Karl Kunisch. "Algorithms for PDEconstrained
589 optimization." GAMMMitteilungen 33.2 (2010): 163-176.
- 590 [25] Gunzburger, Max D. Perspectives in flow control and optimization. So-
591 ciety for industrial and applied mathematics, 2002.
- 592 [26] Guest, James K., and Lindsey C. Smith Genut. "Reducing dimension-
593 ality in topology optimization using adaptive design variable fields."
594 International journal for numerical methods in engineering 81.8 (2010):
595 1019-1045.
- 596 [27] Othmer, Carsten. "Adjoint methods for car aerodynamics." Journal of
597 Mathematics in Industry 4.1 (2014): 1-23.
- 598 [28] Andreasen, Casper Schousboe, Allan Roulund Gersborg, and Ole Sig-
599 mund. "Topology optimization of microfluidic mixers." International
600 Journal for Numerical Methods in Fluids 61.5 (2009): 498-513.
- 601 [29] Alexandersen, Joe, et al. Topology optimisation for coupled convection
602 problems. DTU Mechanical Engineering, 2013.
- 603 [30] Alexandersen, Joe, et al. "Topology optimisation for natural convection
604 problems." International Journal for Numerical Methods in Fluids 76.10
605 (2014): 699-721.
- 606 [31] Andreasen, Casper Schousboe, and Ole Sigmund. "Saturated poroelastic
607 actuators generated by topology optimization." Structural and Multidis-
608 ciplinary Optimization 43.5 (2011): 693-706.

- 609 [32] Okkels, Fridolin, and Henrik Bruus. "Scaling behavior of optimally
610 structured catalytic microfluidic reactors." *Physical Review E* 75.1
611 (2007): 016301.
- 612 [33] Deng, Yongbo, et al. "Topology optimization of unsteady incompressible
613 NavierStokes flows." *Journal of Computational Physics* 230.17 (2011):
614 6688-6708.
- 615 [34] Challis, Vivien J., and James K. Guest. "Level set topology optimization
616 of fluids in Stokes flow." *International journal for numerical methods in
617 engineering* 79.10 (2009): 1284-1308.
- 618 [35] Yoon, Gil Ho. "Topology optimization for stationary fluidstructure in-
619 teraction problems using a new monolithic formulation." *International
620 journal for numerical methods in engineering* 82.5 (2010): 591-616.
- 621 [36] Yoon, Gil Ho. "Topology optimization for stationary fluidstructure in-
622 teraction problems using a new monolithic formulation." *International
623 journal for numerical methods in engineering* 82.5 (2010): 591-616.
- 624 [37] Deng, Yongbo, Zhenyu Liu, and Yihui Wu. "Topology optimization of
625 steady and unsteady incompressible NavierStokes flows driven by body
626 forces." *Structural and Multidisciplinary Optimization* 47.4 (2013): 555-
627 570.
- 628 [38] Ramalingom D., Cocquet P.-H. & Bastide A. "Optimisation topologique
629 des échanges thermiques dans un canal vertical asymétriquement
630 chauffé", Accepted for publication in proceeding of the 25th Congrès
631 Français de Thermique (2017)

- 632 [39] Ramalingom D., Cocquet P.-H. & Bastide A. , Numerical study of nat-
633 ural convection in asymmetrically heated channel considering thermal
634 stratification and surface radiation, Submitted. (2017)
- 635 [40] Jenkins, Nicholas, and Kurt Maute. "An immersed boundary approach
636 for shape and topology optimization of stationary fluid-structure inter-
637 action problems." *Structural and Multidisciplinary Optimization* 54.5
638 (2016): 1191-1208.
- 639 [41] Kubo, Seiji, et al. "A level set-based topology optimization method
640 for optimal manifold designs with flow uniformity in plate-type mi-
641 crochannel reactors." *Structural and Multidisciplinary Optimization*
642 55.4 (2017): 1311-1327.
- 643 [42] Desrayaud, G., et al. "Benchmark solutions for natural convection flows
644 in vertical channels submitted to different open boundary conditions."
645 *International Journal of Thermal Sciences* 72 (2013): 18-33.
- 646 [43] Stolpe, Mathias, and Krister Svanberg. "An alternative interpolation
647 scheme for minimum compliance topology optimization." *Structural and*
648 *Multidisciplinary Optimization* 22.2 (2001): 116-124.
- 649 [44] Weller, Henry G., et al. "A tensorial approach to computational contin-
650 uum mechanics using object-oriented techniques." *Computers in physics*
651 12.6 (1998): 620-631.
- 652 [45] Hinze, Michael, et al. *Optimization with PDE constraints*. Vol. 23.
653 Springer Science & Business Media, 2008.

- 654 [46] Zhou, Shiwei, and Qing Li. "A variational level set method for the topol-
655 ogy optimization of steady-state NavierStokes flow." *Journal of Compu-
656 tational Physics* 227.24 (2008): 10178-10195.
- 657 [47] Nrgaard, Sebastian, Ole Sigmund, and Boyan Lazarov. "Topology
658 optimization of unsteady flow problems using the lattice Boltzmann
659 method." *Journal of Computational Physics* 307 (2016): 291-307.
- 660 [48] Koga, Adriano A., et al. "Development of heat sink device by using
661 topology optimization." *International Journal of Heat and Mass Transfer*
662 64 (2013): 759-772.